

Sovereign 100

Tube Guitar Amplifier
with MIDI-Control

Operator's Manual

Please, first read this manual carefully!



ENGL

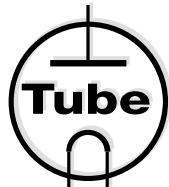

**Amp
Technology**

Table of Contents

	page:
Introduction	4
Features and Functionality at a Glance	4, 5
Contents	6
Front Panel Features:	
Input; Clean and Crunch Channel Control Features	6 - 8
Channel selection, Reverb, FX Loop 1/2	8, 9
Write/Copy	9
Lead I and Lead II Channel Control Features	10 - 12
Power Amp section: Master A/B	12
Stand By, Power	12, 13
Rear Panel Features:	
Mains, Mains Fuse	14
MIDI Section and Footswitch Ports	14 - 16
Noise Gate, Threshold Level	16, 17
FX Loop 1 and 2: Send, Return, and Balance	17, 18
Reverb control CH1, Reverb control CH2	18
Balanced Line Out: Level, Overload LED, Line Out Status,	18, 19
XLR Ground, Line Output Frequ. Comp.	19, 20
Poweramp Output 4, 8 16 Ohms	20
Poweramp Output: speaker options	20, 21
Practical Info and Tips	
On the Subject of Sounds and Settings	22, 23
A few comments on the Noise Gate	23
Electronic safety systems	23
Programming sounds (settings) to MIDI presets	24
Handling and Care	24, 25
Glossary	25, 26
Status-LED: Indications	26
Troubleshooting	27, 28
Important note concerning the cooling fans	28
Technical Data , Detailed Specifications and Ratings	29
Tube Map, Tube Exchange Service	30
Wiring of Principal Connectors	31
Remote Control Options	32
Front Panel Diagrams for Noting Settings	33
Configuration Table Z-9 settings	35

CAUTION! Please read and heed the following:

You'll find an ancillary pamphlet accompanying this owner's manual entitled Instructions for the Prevention of Fire, Electrical Shock and Injury. Be sure to read it before you plug in and power up the amp!

Note: Technical specifications are subject to change without notice.

Congratulations tube tone connoisseur! With the **ENGL Sovereign 100**, you now own one of the **most advanced** and **versatile tube amp combos** available today!

This **sophisticated guitar amp** marries the unrivalled tone of **all-tube technology** to the awesome sound-shaping might of control features powered by **state-of-the-art microchip circuitry**. This elegant combination puts at your fingertips a **vast range of great fundamental tones** and an all but inexhaustible reservoir of compelling variations all of which may be **controlled remotely via MIDI**.

What's more, the amp boasts a host of hip & practical features. To mention just a few, these features include:

Four channels - Clean, Crunch, Lead I and Lead II tweaked to **deliver different tonal spectrums** for various styles and playing techniques, for instance, Lead I for **fast & heavy riffs** and Lead II for **punchy lead tone** with an **assertive midrange kick**. Both Lead channels offer Lo Gain / Hi Gain switching as well as dedicated Volume knobs that give you an even greater range of sound-sculpting options.

With dedicated Treble knobs for the two Clean and Crunch channels, you have at your fingertips extremely precise tone-tweaking tools for those top-end frequencies that are so important in shaping your sound. **A/B Master switching** is a powerful option that has proven its merits in countless ENGL amps (it has featured in E920 power amps since the late '80s and in the legendary SAVAGE 120 head since '93!). Your Sovereign Combo also sports **two switchable effect loops** and an **Accutronics spring reverb system** to round out its arsenal of sound-shaping tools.

The tonal palette ranges from **vintage clean** to **classic grind**, and from **creamy rock lead tone** with **thick, lush tube overdrive** to the kind of **aggressive hi-gain lead sound** it takes to cut through in **contemporary heavy styles**. We developed this amp with the needs of the working musician in mind, painstakingly tweaking its frequency-compensated, balanced Line Out. Rest assured, this output delivers the amp's awesome tube tone directly to mixers and recording systems with amazing authority and authenticity.

As an alternative to operating the amp remotely via a **MIDI foot controller** such as the **ENGL Z-15**, you can also plug in an **ENGL Z-9 Custom Foot Controller** and manipulate key functions directly. What's more, the amp comes with a stereo jack designed to take an **ENGL Z-4 dual footswitch** or a switching system for selecting the four channels. And the **exterior's compelling visuals** certainly match the interior's impressive appointments. This amp's elegant and stylish look is sure to turn heads wherever you play.

Your ENGL Sovereign 100 puts at your disposal:

1. a logical control feature array, utmost **ease of use** and **remarkably intuitive handling**;
2. **excellent sound-shaping options** and **greatest flexibility** courtesy of the many voicing options and 128 MIDI presets offering a bevy of programming options;
3. a **gigging workhorse** that also sports a precise tuned speaker simulation system, making it a handy tool for **studio** and **home recording**;
4. a combination of **finely-tweaked, MIDI controllable sound-shaping functions** providing instant access to a **wealth of disparate sounds**;

5. **four fundamental sounds in finest tube quality:** *Clean, Crunch, Lead I* and *Lead II*, along with **total freedom of tonal expression** that comes courtesy of **Gain switching**, a **four-band EQ** with Presence knobs for both Lead channels, as well as **two separate Treble knobs** for *Clean* and *Crunch* enabling you to dial in precisely the amount of high end you need to **make your tone sparkle**;
6. further tone-tuning options such as an onboard **reverb system** featuring **dedicated controls for each of the two main channels** and a long Reverb spring that conjures **lush, deep and warm reverb**, as well as **two effect loops** that let you factor multi-effect processors into the sonic equation;
7. an **ultra-advanced tone-generating machine** that will give you years of **playing pleasure and value to boot**.

Features and Functionality at a Glance

- > **Four basic channels:** *Clean, Crunch, Lead I* and *Lead II* with separate Gain and Volume knobs, *Clean* and *Crunch* with a separate Treble control.
- > **Two Gain options** for the two Lead channels: *Hi Gain* let you active directly two different gain settings for *Lead I* and *Lead II*, thereby extending the number of potential Lead sounds to four.
- > **Two dedicated and specially tuned voicing sections:** one EQ for *Clean* and *Crunch* (main channel 1) and a 4-band EQ with Presence control for *Lead I* and *Lead II* (main channel 2). As a special feature, the *Clean* and *Crunch* channel sports a dedicated Treble knob each.
- > **Large spring reverb** for very natural-sounding reverb, with separate knobs for the two main channels.
- > **Two effect loops:** *FX Loop 1* and *FX Loop 2* are variable and switchable. Each may be activated separately for every channel or one FX Loop may be used as a hardware bypass.
- > **Two each power amp Master knobs**, accessible via MIDI. The amp can also be muted via MIDI controller 7.
- > **Balanced, frequency-compensated XLR line output** for routing preamp or power amp signals to mixers or recording gear, offering a precisely tuned and very authentic-sounding speaker simulation.
- > *MIDI In* and *Thru* ports serve to integrate the amp into a MIDI system.
- > **128 MIDI presets**, accessible via 16 MIDI channels or OMNI.
- > The **Sovereign combo amp offers three different remote interface ports:** The Serial Amp Control Port accepts the Custom Z-9 Footswitch (optional); use it as a conventional switcher to select channels and two sound-shaping functions directly. Then there's the *MIDI In*, which accepts the Z-9 for use as a simple MIDI footcontroller or any other MIDI footcontroller. Finally, the amp is equipped with a stereo jack that takes a dual footswitch, allowing you to switch the four channels remotely.
- > **Noise Gates** for suppressing high-gain hiss in the *Lead I* and *Lead II* channels.
- > **Two fans for cooling** the power amp section.

Among the hallmarks of this fine amp are painstaking workmanship and finishing as well as rigorously tested and carefully selected quality components. You'll find guidelines on care and maintenance of tube amps on page 24. Under the heading Tips from the designer, you'll come across practical tips on the aforementioned features throughout the manual. All critical information concerning the operation of this amp is preceded by "NOTE", "CAUTION", "Read and heed" or some other eye-catching comment. We're calling your attention to these remarks for reasons of safety or other compelling motives, so please give them due consideration.

Everyone at ENGL is confident that the **Sovereign tube amp's extraordinary versatility** and **outstanding features** are sure to delight you: **Simply plug in, play and be inspired by the tone of your ENGL amp!**

A few words of wisdom from the designer:

Though this amplifier is relatively easy to handle and you're probably raring to give it a go, I recommend that you read the owner's manual thoroughly before you power it up. It is equipped with several safety features that require further explanation to prevent malfunctions.

Contents:

1. ENGL Tube Combo Amp E365 (1x12") or ENGL Tube Combo Amp E368 (2x12") including 4 castors;
2. mains cord;
3. this manual;
4. a pamphlet entitled *Instructions for the Prevention of Fire, Electrical Shock and Injury*.

Front Panel Features

At the back of the manual, you'll find fold-out diagrams of the front and rear panels. As you're reading the descriptions of the amp's features, you'll gain a better understanding of the topic of discussion if you unfold and refer to them as we go!

1 Input

1/4" unbalanced input jack. Plug your guitar in here using a shielded cord.

A tip from the designer:

Depending on the type of cord and its shielding, you may occasionally encounter interference from sources such as radio stations or powerful magnetic fields. When this occurs, try connecting your guitar to the amp using different cords. What's more, to minimize signal degradation due to high-frequency loss, use the shortest cords feasible (as a rule, the shorter the cord, the less susceptible it is to high-frequency attenuation).

2 Clean Gain

Clean channel Gain control. This knob determines the preamp's input sensitivity in Clean mode; use it to set the desired input level.

A tip from the designer:

The amount of distortion depends on your guitar's pickups. In Clean mode, single-coil pickups may begin saturating the preamp when the knob is set to about the two o'clock position; pickups with very high output levels (humbuckers or active pickups) will evoke mild overdrive at even lower settings. If you want squeaky clean tone, simply back off the Gain knob accordingly.

3 Crunch Gain

Gain control for the Crunch channel. This knob determines input sensitivity in Crunch mode; use it to dial in the desired amount of preamp distortion.

CAUTION: Extremely high gain and volume levels in Crunch mode can produce powerful feedback. Avoid feedback squeals; they can lead to hearing loss and damage speakers! At higher volumes, back off the Gain and Treble levels in order to prevent unchecked feedback!

A tip from the designer:

Single-coil pickups will evoke mildly overdriven sounds at settings somewhere between 10 and 2 o'clock. Try settings between 9 and 1 o'clock for pickups with high-output humbuckers or active pickups. For an even bigger, beefier crunch tone, try Crunch Gain settings well beyond the 2 o'clock position.

4 Bright

This feature boosts the upper end of the high frequency range in main channel 1, *Clean* and *Crunch*. The red LED above this button lights up to indicate the Bright function is on. This feature can also be switched via MIDI program change or the Custom Z-9 Footswitch.

A tip from the designer:

For a crisp or glassy tone, activate the *Bright* feature. This setting brightens the sound of humbucking or muddy pickups. This voicing option ups the twang factor inherent in certain types of guitars, and lets you put a set of sonic cow horns on those that lack it. Feel free to control this sound-shaping function remotely via MIDI.

5 Bass

This is the preamp voicing section's passive low-frequency EQ for main channel I's Clean and Crunch modes.

6 Middle

This is the preamp voicing section's passive midrange frequency EQ for main channel I's Clean and Crunch modes.

7 Treble Clean

This is the preamp voicing section's passive high-frequency EQ for main channel I's Clean mode.

8 Treble Crunch

This is the preamp voicing section's passive high-frequency EQ for main channel I's Crunch mode.

A tip from the designer:

To help you get acquainted with the amp's fundamental sounds, I recommend that you set all tone controls to or slightly higher than the center or 12 o'clock position. For higher-gain Crunch sounds, your best bet is to turn the Treble Crunch knob down to prevent the pickups and speakers from generating feedback (a setting in the 10-to -1 o'clock range is recommended).

The Clean and Crunch channels are equipped with dedicated Treble knobs so you can tweak the top end of each of the two channels separately to suit your taste and the given sonic scenario. You will find that grittier tones generally sound better with a touch less treble because preamp saturation makes higher frequencies figure more prominently in the signal. Bear in mind that you also have the programmable Bright (4) button at your disposal for shaping the high frequency range. I suggest you get into the habit of dialing in lower Treble settings. That way, you can program various MIDI presets with different Bright settings and activate them remotely and have plenty of tonal variations at your fingertips.

9 Clean Volume

Determines the Clean channel's level. Use this knob to adjust the Clean channel's volume and dial in the desired balance in comparison with the other channels' levels. Because this knob is located pre effects loop, it also determines the effects send level in Clean mode. The green LED to the right of the knob lights up to indicate the Clean channel is on.

10 Crunch Volume

Determines the Crunch channel's level. Use this knob to adjust the Crunch channel's volume and dial in the desired balance with the other channels' levels. Because this knob is pre effects loop, it also determines the effects send level in Crunch mode. The yellow LED to the right of the knob lights up to indicate the Crunch channel is on.

11 Channel 1/2

Main channel selector button; selects main channel 1 or 2 and, depending on the sub channel settings (12), activates Clean, Crunch, Lead I or Lead II channels. When the LED above the button is off, main channel 1 (*Clean* or *Crunch*) is active. When the LED lights up, main channel 2 (*Lead I* or *Lead II*) is active.

Channels may also be switched via MIDI program change, the ENGL Custom Z-9 Footswitch, or a dual footswitch.

12 Sub I/II

Sub channel selector button; selects Sub Channel I or II: Depending on the main channel settings (11), it activates the *Clean* or *Crunch* and the *Lead I* or *Lead II* channels. When the LED above the button is off, *Clean* or *Lead I* (Sub Channel I) is active. When the LED lights up, *Crunch* or *Lead II* (Sub Channel II) is active. Distinctively colored LEDs are located next to each channel's Volume knob. To make operation and navigation easier for you, they light up to indicate which channel is currently active.

Channels may also be switched via MIDI program change, the ENGL Custom Z-9 Footswitch, or a dual footswitch.

13 FX Loop 1/2

This button switches to and fro between *FX Loop 1* and *FX Loop 2*. The red LED above the button lights up to indicate *FX Loop 2* is on. You can also select loops via MIDI program change or Custom Z-9 Footswitch.

A tip from the designer:

Both effect loops can be configured in series (that is, 100% processed signal when *Balance* is set to *Effect*) or in parallel (1% to 99% mix of preamp and effect signal when *Balance* is set somewhere between *dry* and *Effect*), or be bypassed altogether (0 % wet balance when *Balance* is set to *dry*). You can connect an effect device to each of the effect loops and switch from one effect device to the other using the FX Loop 1/2 function, or employ just one of the two effect loops (for example, FX 2 Loop) and use *FX Loop 1/2* to activate the effect. In the latter case, *FX Loop 1* serves as a bypass (set its *Balance* knob to the *dry* position). Note that in the signal path, *FX Loop 1* and *FX Loop 2* are post the preamp and pre the two master knobs.

14 Reverb

This button activates and deactivates the onboard spring reverb system. The red LED above the button lights up to indicate *Reverb* is active. This button is important when you're programming MIDI patches. Use it to assign the internal reverb signal to the desired MIDI preset. Adjust the wet signal for the two main channels using the assigned Reverb knob (45, 46) located at the rear panel of the amp. *Reverb* can also be switched via MIDI program change or Custom Z-9 Footswitch.

15 Write/Copy

Press this button to store the modified setting of a programmable feature to a MIDI memory slot (generally called a preset). Here's how to distinguish between *Write* and *Copy*: with the former you're actually programming or writing a new MIDI preset, with the latter you're making an exact duplicate of an existing preset.

The system will select a Write operation whenever you edit a MIDI preset, that is, when you have modified a programmable feature. You'll know that this is the case because the Status LED flashes steadily when you edit one or several programmable features. If you press the button and did not edit a MIDI preset, the system will select *Copy*. This means that the given preset becomes the source, and its contents are dumped to another preset and stored there. When you press this button, the Status LED lights up continuously to indicate *Copy* is activated. The system quits *Copy* mode autonomously if you do not select a new MIDI preset within about 30 seconds.

The preset programming process – the Write command, that is – is not carried out as soon as you press the button. Pressing the button merely initiates the process. You must hold it down for about a second until the Status LED flashes three times in rapid succession. This mechanism is designed to prevent inadvertent programming. You can cancel the programming process at any time before the Status LED first illuminates by releasing the Write button. Again, the preset will only be programmed successfully if you press and hold the button until the Status LED flashes three times.

You'll have to go through a similar routine to copy a preset once you select a target preset: When the Status LED extinguishes, the copy operation is underway and can no longer be cancelled. The LED flashes three times to indicate the preset was copied

successfully. You can cancel the copy operation by releasing the key, but only for as long as the LED lights up continuously.

IMPORTANT note; please read and heed:

MIDI preset 1 activates when the amp is powered up. If you want to edit and/or store other MIDI presets, you must connect a MIDI foot board or another MIDI send device to the *MIDI In* port (33) and use this outboard device to select the desired MIDI preset on the amp.

More good-to-know info:

Note that the Status LED also indicates the status of components unrelated to *Write* and *Copy*. The microcontroller runs a short system check after you switch the amp on. Should it find a defect in the memory chip (EEPROM), the LED will flash in a pattern of five short bursts. More info about the Status LED on page 26.

Press the Write/Copy copy button to confirm that you got the message. Once you have done this, the system will be ready to run, although you may encounter problems when attempting to select or store MIDI preset.

Further indicator functions: *Power Tube Monitor*, description in section 28, page 13.

The Status LED serves a third display function. As described in section 53 on page 20 and page 23, it indicates that no speaker is connected to the power amp outputs.

16 Lead I Gain

This knob determines the Lead I channel's input sensitivity and preamp saturation level.

CAUTION: Extremely high gain and volume levels in Lead mode can produce powerful feedback. Avoid feedback squeals; they can lead to hearing loss and damage speakers! At higher volumes, back off the Gain, Treble and Presence levels in order to prevent unchecked feedback!

A tip from the designer:

The two Lead channels' fundamental tones are not worlds apart: *Lead I* boasts slightly less gain and bottom end, but its speedier response makes it a great choice for brisk riffing and lightning lead runs. The Lead I channel is voiced with scooped mids, making it an excellent choice for dialing in hip heavy metal sounds.

17 Lead II Gain

This knob determines the Lead II channel's input sensitivity and preamp saturation level.

CAUTION: Extremely high gain and volume levels in Lead mode can produce powerful feedback. Avoid feedback squeals; they can lead to hearing loss and damage speakers! At higher volumes, back off the Gain, Treble and Presence levels in order to prevent unchecked feedback!

A tip from the designer:

The two Lead channels' fundamental tones are not worlds apart: *Lead II* boasts a bit more gain and bottom end than *Lead I*, and works very well for fat, in-your-face solos and chunky riffs with a big bottom end with plenty of low-frequency punch. Its response is not quite as speedy as *Lead I*'s, and the low-end can turn muddy at high Gain settings in combination with high-testosterone pickups. Note that certain midrange frequencies are boosted in the Lead II channel for a punchier tone, ensuring your lead lines cut through.

18 Gain Lo/Hi

Pressing this button ups input sensitivity, thereby increasing the amplification factor and the amount of distortion in both main channel 2's Lead I and Lead II modes. The LED above this button lights up to indicate *Hi Gain* is active. This feature can also be switched via MIDI program change or Custom Z-9 Footswitch.

A tip from the designer:

When activated, *Hi Gain* supercharges the amplification factor, switching from *Soft Lead* to *Heavy Lead* and putting both Lead channels into high gear. This doubles the number of basic sounds in main channel 2. The *Soft Lead* setting suffices for high-output pickups - even for playing leads - so you can choose *Lo Gain* if your guitar is shred-approved. *Soft Lead* settings also work for chugging rhythm riffs or as alternative crunch sounds, so give 'em a try. But by all means, for scorching ultra high-gain lead sounds with truckloads of sustain or for power chords with a monster bottom-end, go for the *Heavy Lead* variant with *Hi Gain* (function activated).

19 Bass

This is the preamp voicing section's passive low-frequency EQ for main channel 2's Lead I and Lead II modes.

20 Middle

This is the preamp voicing section's passive midrange EQ for main channel 2's Lead I and Lead II modes.

21 Treble

This is the preamp voicing section's passive high-frequency EQ for main channel 2's Lead I and Lead II modes.

22 Presence

This control defines the Treble response in the poweramp stage for main channel 2's Lead I and Lead II modes.

A tip from the designer:

To help you get acquainted with the amp's fundamental sounds, I recommend that you set all tone controls to about the center or 12 o'clock position. For higher-gain, high-volume lead sounds, your best bet is to turn the Treble and the Presence knob down to prevent the pickups and speakers from generating feedback (a setting in the 9-to-1 o'clock range is recommended).

Though this passive voicing section's controls range is narrower than that of a comparable active system, its EQ curve is tweaked specifically for its designated purpose, and will give you satisfying results. What's more, in combination with the Presence control feature in the poweramp stage, you have heaps of voicing options for tailoring basic sounds to taste.

23 Lead I Volume

Determines the Lead I channel's level. Use this knob to adjust the Lead I channel's volume and dial in the desired balance in comparison with the other channels' levels. Because this knob is located pre effects loop, it also determines the effects send level in

Lead I mode. The red LED to the right of the knob lights up to indicate the Lead I channel is on.

24 Lead II Volume

Determines the Lead II channel's level. Use this knob to adjust the Lead II channel's volume and dial in the desired balance in comparison with the other channels' levels. Because this knob is located pre effects loop, it also determines the effects send level in Lead II mode. The red LED to the right of the knob lights up to indicate the Lead II channel is on.

25 Master A

Master A volume knob. Located post effect loops, it controls power amp output. The red LED to the right of the knob lights up to indicate *Master A* is enabled and determining the master level. You can also set the master level to 0 via MIDI controller 7. To learn how to do this, see section 35 in the *Rear Panel Features* chapter.

26 Master B

Master B volume knob. Located post effect loops, it controls power amp output. The green LED to the right of the knob lights up to indicate *Master B* is enabled and determining the master level. You can also set the master level to 0 via MIDI controller 7. To learn how to do this, see section 35 in the *Rear Panel Features* chapter.

A tip from the designer:

Remote control via (MIDI) footswitch is a nifty little utility: You can dial in different levels for *Master A* and *Master B* and assign these settings to any channel and mode that the amp has to offer. This gives you a range of variations that you can program for different playing styles and musical genres to great dramatic effect. You can use main channel 1 Clean & Crunch modes for rhythm or cleaner lead lines and the main channel 2's overdriven preamp stage for power chords and soloing, and go from soft to loud at the touch of a button. You can also broaden the volume and tonal ranges by working your guitars' volume knob. If your arsenal includes MIDI gear - for instance, the ENGL Z-15 MIDI Footcontroller - you can use the amp's master volume mute circuit to swiftly and conveniently set the power amp's level to 0 during short breaks or when switching axes.

27 Master A/B

Switches back and forth between the Master A and Master B knobs. The LEDs next to the knobs light up to indicate which Master knob is active the red LED for *Master A*, the green LED for *Master B*. *MASTER A/B* can also be switched via MIDI program change or the ENGL Custom Z-9 Footswitch.

28 Stand By

Power amp standby switch: Use this switch to silence (0 position) the amp when you take longer break. The amp's tubes stay nice and toasty, and the amp is ready to roll immediately when you ramp it back up to full power.

More good-to-know info:

On the one hand, the amp's surveillance system monitors if speaker cords are plugged

into *Output Power Amp 4 ohms, 8 ohms or 16 ohms* (51, 52, 53). If none of these ports is in use, flipping the Standby switch will not activate the power amp. This ensures the amp is not operated without a connected load.

In addition, an electronic surveillance system monitors the four power tubes. The Status LED flashes to alert you to a defective power tube, blinking in different patterns to identify the given tube. Specifically, it lights up briefly at regular intervals - once for V1, twice for V2, thrice for V3, and four times for V4. Because the tube monitoring system only works when the power tubes are up and running, this indicator is not enabled until you activate the power amp by flipping the Standby switch. To reset the power tube monitoring circuitry, press the standby switch briefly.

A tip from the designer:

I suggest you get into the habit of using standby during short breaks. In this mode, current is not piped through the power tubes, so they don't get as hot (due to the lack of anode dissipation) and are spared considerable wear. The amp is ready to run when you flip the Standby switch because the tubes are already warm and don't require time to heat up. For breaks of 30 minutes and longer, I recommend that you switch the amp off in order to conserve energy.

29 Power

Mains power on/off.

Space for user notes:

Rear Panel Features

At the back of the manual you'll find a folded page offering diagrams of the front and rear panels. Please unfold and refer to it as you read through the descriptions of features and functions!

30 Mains Connector

Plug the mains cord in here. For European models, use a standard non-heating equipment connector cable.

CAUTION: Make sure you use an intact mains line cord with a grounded plug! Before you power the amp up, ensure the voltage value printed above the mains socket is the same as the current of the local power supply or wall outlet. Please also heed the guidelines set forth in the separately included pamphlet, *Instructions for the Prevention of Fire, Electrical Shock and Injury*.

31 MAINS FUSE BOX:

The rear chamber contains the mains fuse and the front chamber a spare fuse.

CAUTION: ALWAYS make sure replacement fuses are of the same type and have the same ratings as the original fuse! To this end, please refer to the fuse ratings table.

32 MIDI THRU

This 5-pin DIN port patches incoming MIDI data from the *MIDI In* (33) to any other connected MIDI device.

33 MIDI IN

This 5-pin DIN port accepts data sent by a MIDI sender (for example, the ENGL MIDI Z-12, Z-15, or Z-9 foot controllers) or from or routed through another MIDI device. Switch no. 34 lets you activate the amp's power supply if you have an ENGL MIDI foot controller connected to this port.

CAUTION: Before you connect any other MIDI footswitch or effects device, always make sure that switch no. 34 is set to the right to avoid damaging the device.

34 POWER SUPPLY FOR THE ENGL MIDI FOOTCONTROLLER

This selector activates a MIDI In port power supply for connected ENGL MIDI foot boards. Power is fed to the board via the MIDI circuit. When the switch is set to the left position, power is routed to the MIDI In port's pin 1 and pin 2 (refer to page 31 for pin assignments). If you choose to use another MIDI foot board, be sure to set the switch to the right to avoid damaging it. If the foot board you are using is designed to handle phantom power, consult its operating manual to learn how it is wired (that is, which pins carry its power supply) and what its voltage and current specifications are. If the voltage and current specifications and wiring match, you may set the switch to the left to power this foot board via the MIDI cable.

Please read and heed: Note that a MIDI foot board may not draw more than 200 milliamperes of current if you want to power it via this port. You must also check and verify if this MIDI foot board is able to handle 11 volts of alternating current (AC)! If you are in any doubt, be sure to consult a specialist, meaning an amp technician or electronics engineer who earns a living with a screwdriver!

35 MIDI CHANNEL & VOL.0

Use this set of encoding buttons (1, 2, 3, 4 and 5) to assign the MIDI channel. This tells the amp's MIDI system over which channel it will receive MIDI program change commands. Your choices are the standard 16 MIDI channels (numbered from 00 to 15), as well as OMNI mode (whereby all MIDI data is received regardless of the MIDI send channel). The encoding button settings for a specific channel and OMNI mode are listed in the following table.

Encoding button number 6 lets you program the amp so that it is muted when it receives a MIDI controller 7 command. When this command has a value of 0 (and less than and equal to 5), the amp's master volume is muted. At values greater than or equal to 5, the amp is back on line at the volume level determined by the currently active Master knob.

Setting the encoding button to ON activates Master Volume Mute.

Setting the encoding button to OFF deactivates Master Volume Mute.

MIDI channel assignment using the encoding buttons:

MIDI-channel:	S 1	S 2	S 3	S 4	S 5	S 6
OMNI	OFF	XX	XX	XX	XX	XX
CH 1	ON	OFF	OFF	OFF	OFF	XX
CH 2	ON	OFF	OFF	OFF	ON	XX
CH 3	ON	OFF	OFF	ON	OFF	XX
CH 4	ON	OFF	OFF	ON	ON	XX
CH 5	ON	OFF	ON	OFF	OFF	XX
CH 6	ON	OFF	ON	OFF	ON	XX
CH 7	ON	OFF	ON	ON	OFF	XX
CH 8	ON	OFF	ON	ON	ON	XX
CH 9	ON	ON	OFF	OFF	OFF	XX
CH 10	ON	ON	OFF	OFF	ON	XX
CH 11	ON	ON	OFF	ON	OFF	XX
CH 12	ON	ON	OFF	ON	ON	XX
CH 13	ON	ON	ON	OFF	OFF	XX
CH 14	ON	ON	ON	OFF	ON	XX
CH 15	ON	ON	ON	ON	OFF	XX
CH 16	ON	ON	ON	ON	ON	XX

A tip from the designer:

As the table indicates, encoding button 1 switches between Poly and OMNI mode. Bear this in mind for practical applications, because this is a fast way to go from a preset Poly channel to OMNI mode and vice versa.

36 FOOTSWITCH: SERIAL AMP CONTROL PORT

This serial data input accepts the Custom ENGL Z-9 Footswitch (optional), which lets you control various amp functions remotely. Connect the Z-9 Footswitch to the amp port using a cord equipped with stereo ¼" jack plugs. This MIDI-enabled foot board is a custom design that switches every amp feature designated as footswitchable in this manual. To learn if a given feature may be controlled remotely, refer to its description

herein. The MIDI In port is disabled when the Z-9 Footswitch is connected. A configuration table for the functions of the Sovereign 100 amp is printed on page 35.

CAUTION: Connect only the ENGL Z-9 Footswitch to this 6.3 mm (1/4") stereo jack! Connecting any other switching device may damage it and/or the amp's circuitry!

A tip from the designer:

The Custom Z-9 Footswitch was designed with the non-MIDI guitarist in mind. It's sure to delight if you don't or won't use MIDI systems. Based on a rather nifty switching concept, it provides direct access to the four channels. Alongside selecting channels, you can opt to control any other two switchable amp functions, for example, *Master A/B*, *Reverb*, *Gain Lo/Hi*, etc. Another tremendous benefit of this microcontroller-driven foot board is that it connects to the amp via an easily obtained, standard stereo cord. But that's not the last of the Z-9's advantages: At some point, you may decide to ramp up or connect to a MIDI system. This won't render the Z-9 obsolete because it also serves as a simple MIDI foot board with a MIDI OUT (5-pin DIN connector) that selects 10 MIDI patches (or presets, if you prefer). Again, I want to emphasize that you should never connect another foot board to this jack: The Z-9 controls the amp via a proprietary ENGL serial data protocol, and the Serial Amp Control Port was developed exclusively for ENGL amps. No other foot board will work and in fact is likely to damage the foot board or amp's circuitry!

37 FOOTSWITCH: CH 1 /CH 2, SUB I/II

Use this jack to connect a conventional footswitch with two switching functions (for example, the ENGL Z-4) that let you access the four channels *Clean*, *Crunch*, *Lead I* and *Lead II*. One of the two switches activates main channel 1 and 2, while the other activates the selected main channels two subordinate channels, *Clean* and *Crunch* or *Lead I* and *Lead II*, as the case may be. The onboard channel switching facility, is disabled when you plug a footswitch into this jack.

Note also: A footswitch may be equipped with LEDs indicating the given switching status. Each of the two switches is provided with 15 milliamperes current, which suffices to power a standard LED.

The jack's mono terminal selects the main channel, while the stereo terminal selects the sub channel (refer to Pin Assignments on page 31).

38 NOISE GATE THRESHOLD LEVEL

This knob activates an onboard Noise Gate serving to suppress excess noise in main channel 2 (*Lead I* and *Lead II*) when you twist it to the right, past about the 9 o'clock position.

Use this knob to set a threshold value (that is, the noise level) at which the Noise Gate activates to suppress the signal within the 9 to 5 o'clock range. The further you twist the knob to the right, the higher the signal level at which the Noise Gate kicks in.

A tip from the designer:

Soft Lead and *Heavy Lead* generate different levels of noise, and I tuned the ENGL Sovereign's *Noise Gate* accordingly. However, there is some minor matching variance between the two. *Heavy Lead* (*Lead channel* and *Hi Gain* activated) stands to benefit most from the *Noise Gate*, so I suggest that you tweak its two knobs for this mode.

Noise is a definite no-no in many situations. For example, studio etiquette demands that you keep a lid on extraneous noise during short breaks. It's in the nature of high-gain rigs to generate undesirable peripheral noise in overdriven channels. This is attributable to the physical properties of an amp's constituent components, in particular its active components. That's right; those cherished tubes are the culprits. The Noise Gate is a tool that lets you silence this noise during breaks by way of signal mute circuit. Note that electric guitars pick up interference signals, and these are amplified tremendously at high gain levels in Lead mode. The most common source of noise is 50 or 60 hertz mains hum, particularly when the guitar is positioned near transformers and power units. Because in worst-case scenarios this humming can attain extremely high levels, the Noise Gate can hardly distinguish between the musical signal and noise. This makes it hard to find the right Threshold setting. It is entirely possible for this humming and other noise to rise to a level that deactivates the *Noise Gate* and therefore becomes audible. My advice is to stay as far away from transformers and power units as space allows.

IMPORTANT note; please read and heed: The *Noise Gate* may open up inadvertently when the *Noise Gate* is activated, a high-gain Lead channel is selected, and the volume exceeds the Threshold knob setting. At very high volume and gain settings, this may generate instant feedback, particularly if your guitar is facing the speakers. Rather than musical and controlled, this is the shrill, unpleasant and potentially harmful variety of feedback squealing that sends your audience and fellow musicians packing. Though the amp is not more susceptible to feedback when the *Noise Gate* is activated, the fact that it suppresses extraneous noise means you can't hear those telltale signs that feedback is swelling and consequently can't take measures to suppress it. For this reason, make an extra effort to be careful when the *Noise Gate* is activated: Before you approach the amp and speaker cabinet with your guitar in hand, turn the guitar's volume knob to the far left position (to 0 so that no signal is audible) to prevent the pickups and speakers from interacting!

39 FX LOOP 1 SEND

Connect this FX Loop 1 output to a signal processor's input/return jack using the shortest possible shielded cord equipped with 1/4" plugs. Activate and deactivate it via the FX Loop 1/2 (13) button, which switches between these two loops. In the signal path, *FX Loop 1* is located post preamp and pre the two power amp Master knobs.

40 FX LOOP 1 RETURN

Connect this FX Loop 1 input to a signal processor's output/send jack using the shortest possible shielded cord equipped with 1/4" plugs. Activate and deactivate it via the FX Loop 1/2 (13) button, which switches between these two loops. In the signal path, *FX Loop 1* is located post preamp and pre the two power amp Master knobs.

41 BALANCE

FX mix control for *FX Loop 1*. When the knob is set to *Dry*, the amp signal is routed through with no processed signal (0% wet balance) added to the mix. Twist the knob clockwise to blend in the processed signal (parallel/passive, wet balance 1-99%, depending on knob position). When the knob arrives at the Effect position, only the

wet signal (that is, the processed signal generated by the connected effect device) is patched to the power amp (serial, 100% wet).

NOTE: Set this knob to *Dry* when this loop is not in use!

42 FX LOOP 2 SEND

Connect this FX Loop 2 output to a signal processor's input/return jack using the shortest possible shielded cord equipped with 1/4" plugs. Activate and deactivate it via the FX Loop 1/2 (13) button, which switches between these two loops. In the signal path, *FX Loop 2* is located post preamp and pre the two power amp Master knobs.

43 FX LOOP 2 RETURN

Connect this FX Loop 2 input to a signal processor's output/send jack using the shortest possible shielded cord equipped with 1/4" plugs. Activate and deactivate it via the FX Loop 1/2 (13) button, which switches between these two loops. In the signal path, *FX Loop 2* is located post preamp and pre the two power amp Master knobs.

44 BALANCE

FX mix control for *FX Loop 2*. When the knob is set to *Dry*, the amp signal is routed through with no processed signal (0% wet balance) added to the mix. Twist the knob clockwise to blend in the processed signal (parallel/passive, wet balance 1-99%, depending on knob position). When the knob arrives at the Effect position, only the wet signal (that is, the processed signal generated by the connected effect device) is patched to the power amp (serial, 100% wet).

NOTE: Set this knob to *Dry* when this loop is not in use!

45 REVERB CHANNEL 1

Reverb intensity knob. Twist it to adjust the amount of reverb for main channel 1 *Clean/Crunch*. Activate *Reverb* (button 14 at the front panel) and twist the Reverb knob clockwise to increase the effect's intensity. The signal remains completely dry when the knob set to the 7 o'clock position or *Reverb* (14) is deactivated. The red LED above this button lights up to indicate *Reverb* is on. In addition, it can be activated and deactivated via MIDI program change or Custom Z-9 Footswitch.

46 REVERB CHANNEL 2

Reverb intensity knob. Twist it to adjust the amount of reverb for main channel 2's Lead I and Lead II modes. Activate *Reverb* (button 14 at the front panel) and twist the Reverb knob clockwise to increase the effect's intensity. The signal remains completely dry when the knob set to the 7 o'clock position or *Reverb* (14) is deactivated. The red LED above this button lights up to indicate *Reverb* is on. In addition, it can be activated and deactivated via MIDI program change or Custom Z-9 Footswitch.

47 LEVEL

This knob determines the level of the frequency-compensated Line Out (50). Use it to adjust the amp's line output signal level to match the input gain of the mixing desk or recorder's input.

A tip from the designer:

The following factors determine Line Out level (50):

The input level (Gain), the given channels' Volume knob settings as well as the activated Master and, to some extent, the voicing section's settings and the Presence control when button 48 is set to the "Power Amp" position.

Those are a lot of variables, so I recommend you proceed as follows: Configure buttons as desired and dial in the desired settings on the front panel. Adjust the levels of connected FX devices and signal processors. Finally, use the Level control to adjust the line level. The Line Out is not overloaded until the Overload LED (above the Status knob) lights up continuously. You can push the level up to this point to match a mixer desk or recorder's input level requirements. Use the given device's input sensitivity or gain control to fine-tune the line level.

OVERLOAD

This LED lights up to tell you the Line Out is saturated. If it illuminates, simply roll back the signal level using the Level knob (47).

48 LINE OUT STATUS

This button selects the signal source for the Line Out signal routed to the XLR port (50). When set to OFF, the line signal is tapped from the preamp.

When set to ON (pushed in), the line signal is tapped from the power amp. At least one speaker must be connected for this option!

A tip from the designer:

The ENGL Sovereign's preamp and power amp supply two different signals. The reason for this is that the Presence control, the power tubes and output transformer all shape the power amp signal's tone. You may have to adjust the voicing controls on your amp, mixer desk or recorder to adjust the line out signal accordingly.

49 XLR GROUND

This switch assigns pin 1 of the XLR port (50) to ground (Ground to Pin 1). You'll find that this is a handy option when you want to earth the circuit you have routed to a mixing console or recording device.

IMPORTANT NOTE: You encounter something called a ground loop if your amp is connected to a mixing console or recording gear and pin 1 of both devices' XLR connectors serve as ground terminals (the XLR Ground button on the amp is set to Ground to Pin 1). A ground loop is readily identified by the infernal humming emanating from your speakers. Set this button to *Ground Lifted* to solve the problem!

50 LINE OUT BALANCED & FREQU. COMP.

This is a frequency-compensated, balanced XLR line output. Pins 2 and 3 of the XLR jack carry the signal, pin 1 = N.C. or ground depending on the position of the Ground switch (49). Refer to page 31 to learn more about this. The signal routed to this output limits the response of an ENGL 412 cab. Dial in the desired signal level for the balanced Line Out by adjusting the Level knob (47).

A tip from the designer:

You can patch signals routed through these outputs directly to the balanced inputs a

mixing console or recording gear. The advantage of a balanced circuit is that it is immune to ground loops, provided of course it is wired correctly. You can also patch the line out signal to an unbalanced input using an adapter. To do this, you'll need a shielded cord equipped with an XLR connector and an RCA connector or ¼" plug that bridges the signal (pin 2 or 3) and ground circuits. Be sure to set the button to Ground to Pin 1.

51 POWERAMP OUTPUT, 4 OHMS PARALLEL

4 ohms speaker output jacks, internal connected parallel. For diverse cabinet options see the last chapter on this page!

52 POWERAMP OUTPUT, 8 OHMS PARALLEL

8 ohms speaker output jacks, internal connected parallel; the internal 8 ohms speaker (E365 - 112 combo: 1x 8 ohms) is connected to one of this two jacks. For diverse cabinet options see the last chapter on this page! The impedance of a additional cabinet should bear 8 ohms (for the Sovereign combo amp, type E365).

53 POWERAMP OUTPUT, 16 OHMS

16 ohms speaker output jack; the internal two speakers (E368 - 212 combo: 2x 8 ohms speakers connected in series, results 16 ohms) are connected to this jack. For diverse cabinet options see the last chapter on this page! The impedance of a additional cabinet should bear 16 ohms (for the Sovereign combo amp, type E368).

IMPORTANT NOTE, please read and heed: Never operate the power amp without a sufficient load, otherwise you may damage or destroy it!

An electronic surveillance system constantly monitors if a plug is inserted into the speaker outputs 4 ohms, 8 ohms and 16 ohms (51, 52, and 53). If a plug is not inserted into one of these 5 jacks, the power amp is disabled and the Status LED flashes in a distinctive pattern to alert you to this. However, the system cannot check if a speaker is actually connected to the other end of the cord. That's your job.

Always check and verify that the amp's output impedance matches the connected cabinets' impedance!

Choose only one of the following speaker and cabinet options, depending on your amp model:

A) Speaker and cabinet options for the E365 - 1x12" model only:

1. Internal speaker (1x12", 8 ohms) only, connected to an 8-ohm jack (without an external speaker cabinet!);
Summary: No external cab; internal 8 Z -> internal to 8-ohm output.
2. An external 8-ohm cabinet and the internal speaker (1x12", 8 ohms) connected to the 4-ohm jacks. When you unplug the cable for the external cabinet, ensure you plug the internal speaker back into a 8-ohm jack!
Summary: External 8 Z + internal 8 Z -> external to 4-ohm + internal to 4-ohm output.
3. An external 16-ohm cabinet connected to one of the 8-ohm jacks and the

internal speaker (1x12", 8 ohms) connected to one of the 4-ohm jacks.
When you unplug the cable for the external cabinet, ensure you plug the internal speaker back into one of the 8-ohm jacks!
Summary: External 16 Z + internal 8 Z ->
external to 8-ohm + internal to 4-ohm output.

B) Speaker and cabinet options for the E368 - 2x12" model only:

1. Internal speakers (2x12", 16 ohms) only, connected to the 16-ohm jack;
Summary: No external cab; internal 16 Z -> internal to 16-ohm output.
2. An external 16-ohm cabinet and the internal speakers (2x12", 16 ohms) connected to the 8-ohm jacks. When you unplug the cable for the external cabinet, ensure you plug the internal speakers back into the 16-ohm jack!
Summary: External 16 Z + internal 16 Z ->
external to 8-ohm + internal to 8-ohm output.
3. An external 8-ohm cabinet connected to one of the 4-ohm jacks and the internal speakers (2x12", 16 ohms) connected to one of the 8-ohm jacks. When you unplug the cable for the external cabinet, ensure you plug the internal speakers back into one of the 16-ohm jacks!
Summary: External 8 Z + internal 16 Z ->
external to 4-ohm + internal to 8-ohm output.

C) Cabinet options for the E365 - 1x12 and the E368 - 2x12" model without using internal speaker/s:

1. One external 4-ohm cabinet connected to a 4-ohm jack
(without internal speaker/s !);
Summary: External 4 Z, no internal -> external to 4-ohm output.
2. Two external 8-ohm cabinets connected to the 4-ohm jacks
(without internal speaker/s!);
Summary: External 8 Z + 8 Z, no internal -> external to 4-ohm + 4-ohm
3. One external 8-ohm cabinet connected to an 8-ohm jack
(without internal speaker/s!);
Summary: External 8 Z, no internal -> external to 8-ohm output.
4. Two external 16-ohm cabinets connected to the 8-ohm jacks
(without the internal speaker/s !);
Summary: External 16 Z + 16 Z, no internal -> external to 8-ohm + 8-ohm output.
5. One external 16-ohm cabinet connected to the 16-ohm jack
(without the internal speaker/s !).
Summary: External 16 Z, no internal -> external to 16-ohm output.
6. An external 8-ohm cabinet connected to one of the 4-ohm jacks in combination with a second external 16-ohm cabinet connected to one of the 8-ohm jacks
(without the internal speaker/s !).
Summary: External 8 Z + 16 Z, no internal ->
external to 4-ohm + external to 8-ohm output.

Please note: When you unplug the cable for the external cabinet/s, ensure you plug the internal speaker/s back into one the appropriate output jack!

A few words from the designer on your ENGL Sovereign Amp's sounds and settings as well as some practical tips:

On the Subject of Sounds and Settings

A great deal of effort went into tuning this tremendously versatile combo amp; I devoted particularly painstaking attention to the details: The Clean and Crunch channels are matched so that their Gain ranges overlap somewhat; the same goes for *Lead I* and *Lead II* and the two Gain levels Lo and Hi. This is intentional, and serves very sensible sound-sculpting purposes. For instance, higher Gain settings (in the 1-to-5 o'clock range, depending on pickups) push the Clean channel into moderate overdrive. This means you can use this channel for ultra clean chord work, jazz-style comping and clucking chicken-picked lead lines. And courtesy of that typical tube overdrive, it means the same channel is great grittier riffs and leads, with the amount of dirt hinging upon how hard you attack the strings. If you add the guitar's volume knob to the sonic equation, you get a vast spectrum of fine tonal distinctions in just this one channel. The same goes for the Crunch channel: Its spectrum ranges from clean (when Gain is set no higher than about 10 o'clock, depending on pickup) to fat, wooly, and warm tube overdrive at higher Gain settings. High-output pickups such as humbuckers will even serve up enough oomph for punchy leads. Though these application areas overlap somewhat, the Crunch and Clean channels are voiced differently. When used in combination with high-output pickups, I recommend that you roll off the bottom-end a touch to forestall low-end mud.

main channel 1 (*Clean* and *Crunch*) voicing controls respond differently than those of main channel 2. In consequence, I suggest that you start by dialing in settings between 12 and 3 o'clock, tweaking each to taste and comparing the differences. Again, I opted for passive tone controls, which puts each knob's control range at about 10 dB.

All these options harbor vast and musically meaningful sonic potential. I'm confident that the Gain knobs, tone controls and sound-shaping buttons will let you conjure all the sounds you have in mind and that you'll discover a world of tones while you're tweaking.

In addition, I made a point of tuning the two Lead channels to respond slightly differently: *Lead I*'s response is a bit more aggressive, faster and more precise it all but lunges when you attack strings. *Lead II*, on the other hand, is not quite as testy. Its response is not as rabid, and with an extra sprinkling of low end added to the sonic recipe, it also delivers warmer tone. What's more, Lead II channel mids in the 500 to 1000 Hz range are boosted to focus and tighten up the tone. This makes it perfect solos that cuts through the din. *Lead II* demands rather precise technique, while the more forgiving *Lead I* is easier to handle. *Gain Lo/Hi* gives you two more voicing options for each of the two Lead channels - *Soft Lead* (moderate Gain level) and *Heavy Lead* (ultra high Gain shred). What's more, you can even tweak each Lead sound individually using the dedicated Gain and Volume knob. This brings a bunch of benefits to you, including greater freedom and precision in fine-tuning the various Lead tones. The two Soft Lead variants (*Lead I + Lo Gain*, *Lead II, + Lo Gain*) run the gamut of crunch tones from light (with the Gain knob set no higher than 11 o'clock) to heavy crunch (with the Gain knob somewhere between 10 and 1 o'clock), with tonal properties differing quite markedly from Crunch channel sounds. These modes even let you dial in relatively lean clean sounds. So if clean is your thing and your music

mandates a range of different clean variants, simply set the Gain knob below the 9 o'clock mark and select *Soft Lead* (Lo Gain) to see what you can come up with. Because it is chock full of tone-tweaking tools, this amp is sure to surprise you time and again with new sonic variants. However, there's no need to panic in face of its sophisticated functionality. At ENGL, ease of use is paramount. We design all our amps so that players can dial in great sounds from the start - without hours spent researching the manual and struggling with settings. Despite being so easy to use, the ENGL Sovereign 100 Amp puts into the hands of the innovative, creative guitarist an all but inexhaustible bonanza of sound-shaping resources. And I am convinced that guitarists with more traditional leanings are equally well-served with this amp's smorgasbord of tasty tube tone!

A few comments on the Noise Gate:

The advantage of a *Noise Gate* that is installed in and matched to the amp is that it lets you fine-tune its threshold with extreme precision, thereby separating the useful, musical signal from useless background noise. Indeed, this *Noise Gate* was designed to address the signal the most beneficial spot in the signal chain - the preamp - to make it more effective. First and foremost, it is designed to suppress ambient noise such as hissing and humming during breaks when the Lead channel is in Heavy Lead mode. For this reason, I tuned its threshold (that's the level at which the gate triggers) range to suit this amp mode, and then adjusted it for *Soft Lead* (Lead channel, *Lo Gain*) configurations. To get acquainted with how the *Noise Gate* works, I suggest you start by setting the Threshold knob to the 9 o'clock position (*Noise Gate* opens at low signal levels) and slowly twist it clockwise to gradually raise the gate's trigger threshold. When the knob arrives at the far right position, the *Noise Gate* will not trigger until the signal reaches a very high level. This means that the preamp must amplify the guitar signal considerably to open up (or deactivate) the *Noise Gate*. In practice, your best bet for suppressing loud noise when running Lead channels at high Gain levels is to set the Threshold knob higher than 12 o'clock. If you're doing the low-gain thing in *Soft Lead* modes, dial in a lower Threshold knob setting (below 12 o'clock) to prevent the gate from throttling notes (that is, the musically useful sounds) as they decay particularly if you like to work the guitar's volume knob.

Electronic safety systems:

We endowed the amp with MIDI functionality and programmable settings, which mandate a microprocessor. This afforded me the opportunity to put that processor to even better use and employ it to power a couple of reassuring protection systems. One is Power Tube Monitoring, which checks every power tube individually; the other is a speaker output surveillance system designed to prevent the potentially destructive operation of the power amp without a load. For reasons of operating safely, tube amps require a load such as a speaker cabinet connected to the output. Be aware, though, that as sophisticated as these features may be, they can't relieve you of all responsibility. For example, the system can't detect if a cabinet is connected to the other end of the cord. Please make a habit of checking this before powering the amp up. As a rule, always exercise due caution when operating this baby.

Programming sounds (settings, actually) to MIDI presets:

For reasons of convenience and handling ease, we made programming sounds to MIDI presets a piece of cake. Because this amp offers many programmable switching functions, *Copy* is indeed a handy tool. It lets you copy the settings of one MIDI preset to another. You'll come to appreciate its utility when you begin programming your own presets. Dumping a stored setup from one MIDI preset to another, and editing and storing changes in the target preset, is so much faster and more convenient than programming from scratch every time. MIDI preset 1 is called up automatically when you switch the amp on. This ensures that when you power up, the settings for programmable sound-shaping functions are immediately enabled in the configuration stored in the most recent programming session - without having to first connect a MIDI foot board.

The programming process in steps:

1. Select the desired MIDI program (also called a preset or patch) using a MIDI foot board connected to the amp's *MIDI In*.
2. Set all programmable features as required, configuring *Lead I*, *Gain Lo/Hi*, *Master A*, *Reverb Active*, *FX Loop II*, and so forth as you please. All programmable functions are designated as such in their descriptions herein.
3. The Status LED flashes to indicate you have edited one or several settings.
4. Press and hold the Write/Copy button (15) for about one second until the Status LED extinguishes, and then flashes three times in rapid succession. The current settings of all programmable functions are now stored in the selected MIDI patch.

Copying:

1. Select the desired MIDI preset using a MIDI foot board connected to the amp's MIDI In port. This is the preset that you want to copy, which is why in geek-speak it is called the "source."
2. Press the Copy/Write button briefly. It is essential that during this routine you do not change the settings of programmable functions in the selected source preset. That Status LED lights up continuously to indicate that Copy is activated.
3. Select the target preset via the MIDI foot board; you have approx. 30 seconds to do this. (The amp automatically quits Copy mode 30 seconds after it is activated.)
4. Press and hold the Write/Copy button (15) until the Status LED extinguishes, and then flashes three times in rapid succession. The current settings of all programmable functions stored in the source MIDI patch (that's the preset you selected first when you activated *Copy*) have now been dumped to the newly selected target preset.

Handling and Care:

Keep the amp safe from hard knocks and shocks. Tubes are fragile and tend to suffer when exposed to mechanical stress!

Let the amp cool down before you transport it. Ten 10 minutes or so will do to spare the tubes.

Tubes take some 20 seconds to warm up after you switch the power on, and about

two to three minutes before they are able to pump out full power. Make a habit of giving your amp plenty of time to get toasty and of flipping the Standby switch for short breaks.

Avoid storing the amp in damp or dusty rooms to spare jacks, switches and potentiometers. If you don't use the amp all the time, I recommend that you drape a covering over it to prevent the intrusion of dust. Even better, keep it in a transport cover or flight case.

Never use caustic or scouring detergents to clean the amp's housing, front or rear panels. Use a soft, damp cloth or sponge with diluted soapsuds or a standard brand of mild dishwashing liquid instead. Never use solvents they can corrode the amp's vinyl skin and dissolve the front and rear panel labels. Keep liquids well away from the amp, particularly the interior of the housing.

Make sure air can circulate at the rear and top of the amp to allow for adequate cooling, which increases component life.

Never operate the amp without an adequate load (a speaker, cabinet or suitable terminating resistor).

High ambient temperatures place an additional strain on diverse components; so if at all possible, avoid operating the amp at temperatures far higher than 30°C for longer periods. Running the amp at mains voltages exceeding the nominal mains input voltage over longer periods can also shorten component life.

Replace tubes with selected tubes that satisfy ENGL selection criteria to forestall microphonic properties, undesirable noise and unbalanced power amp signals. Because power tubes' idle current (bias) must be checked and possibly adjusted when replacing tubes, this is a job best left to experienced and authorized specialists.

Glossary

MIDI-Preset:

In this manual, MIDI programs are called presets and patches.

Though the MIDI standard defines program numbers 000 to 127, almost all MIDI devices and foot boards indicate and control these programs using a 1-to-128 numbering scheme.

MIDI Channel:

MIDI specifications define 16 channels for sending and receiving MIDI data. The encoding buttons on the back of the amp determine the MIDI data receiver channel. MIDI channels: 1 to 16, or OMNI (meaning that all 16 channels receive MIDI data).

MIDI-Volume and Master Volume Mute:

This option lets you access the amp's Master Volume Mute function via a suitable MIDI

foot board. This foot board must like the ENGL Z-15 - be able to send MIDI controller 07 data. In order to afford access to Master Volume Mute, this function must be enabled using the corresponding encoding button on the back of the amp.

Power Tube Monitor:

An electronic surveillance system that monitors each power tube's current and shuts the given tube down when it detects a value that is too high.

The Status LED above the Write/Copy (15) button indicates the following conditions:

1. Memory error (possibly a defect in the EEPROM); Indication: LED flashes in five short bursts; What to do: Press the Write/Copy button (this resets the LED, but does not solve the problem).
2. No speaker connected; Indication: The LED flashes in a distinctive pattern, illuminating briefly at regular intervals; What to do: Connect a speaker.
3. A programmable function's (or functions') setting(s) has (have) been edited; Indication: LED flashes regularly; What to do: If desired, restore this MIDI preset's original configuration (e.g. by selecting it again); the Status LED also extinguishes once the new setting has been stored.
4. Copy process was activated by pressing the Write/Copy button; Indication: LED lights up continuously; What to do: If desired, cancel the Copy operation by changing the setting of a programmable feature; the Status LED also extinguishes once the preset has been copied.
5. Power Tube Monitor: A problem or overload in power tube V1; Indication: LED flashes in 1 short burst, followed by a longer pause, etc.; What to do: Activate and deactivate Standby.
6. Power Tube Monitor: A problem or overload in power tube V2; Indication: LED flashes in 2 short bursts; What to do: Activate and deactivate Standby.
7. Power Tube Monitor: A problem or overload in power tube V3; Indication: LED flashes in 3 short bursts; What to do: Activate and deactivate Standby.
8. Power Tube Monitor: A problem or overload in power tube V4; Indication: LED flashes in 4 short bursts; What to do: Activate and deactivate Standby.

Troubleshooting

Programmable features fail to respond when you change settings:

- > Powerful static charges, strong radio signals or mains voltage spikes can affect microcontroller-driven systems, setting them to an undefined status (commonly called a hung chip). In this event, your only choice is to reset the system. Simply switch the amp off and on again.
- > If a reset doesn't solve the problem that is, the chip is still hung there is a defect in the control system (presumably on the logic board holding the microcontroller). In this case, consult an authorized service center or a professional specialist.

The amp fails to respond when you try to switch presets via MIDI foot board.

- > Is the MIDI foot board connected to the MIDI IN port (33)?
- > Is the MIDI cord you are using intact and wired properly? (Refer to page 31 for pin assignments.)
- > Is the amp set to the MIDI channel over which the MIDI foot board is sending program change commands? You can set the encoding button (35) to OMNI reception to check if the preamp is actually receiving data.
- > Is another foot board (the ENGL Z-9 or a two-way footswitch) connected and therefore blocking MIDI reception?

The amp is not providing an output signal / no sound is emanating from the speaker.

- > Is at least one speaker connected to the speaker outputs *4 ohms, 8 ohms or 16 ohms* (51, 52, 53)?
- > Is the power amp activated (Standby switch to ON)?
- > Are all cords (guitar, effect, and speaker) connected properly and are they functional?
- > Unplug connected effectors and see if the preamp works fine without these peripheral devices.
- > Is the Noise Gate activated in one of the Lead channels and the Threshold (38) knob set to a high value? Deactivate the Noise Gate (38) for a quick check.
- > Are the active Master knob and the Gain and Volume knobs set to a value greater than 0? If any of these knobs is set to 0, no signal is routed to the amp's outputs.
- > Did you send via MIDI foot board a MIDI controller 7 command with a value less than or equal to 5? This activates Master Volume Mute, thereby silencing the amp.
You can check this by deactivating the Master Volume Mute by resetting the appropriate encoding button (35) accordingly.
- > You may be looking at a faulty tube or another defect. In this case, be sure to take the preamp to an authorized, professional service center.

The speaker is emitting humming noises:

- > Is there a connection (for example, via a shielded circuit) between the

amp and another device that is grounded via a power plug of its own? Two or more circuits sharing a common electrical ground line can cause audible hum. If low-frequency noise is emanating from your rig, be sure to consult a specialist.

- > The amp and mains grounds are not connected properly or are altogether disconnected. Have an experienced specialist check this.
- > Cords connected to the input or effect loops may not be shielded properly. Replace them to check if this is indeed the case.
- > The amp or speaker cords may be picking up interference from powerful magnetic fields (for example, of nearby power transformers or electrical motors). Reposition the amp and connector cables.
- > The amp or speaker cords may be picking up radio signals, for example, from activated mobile telephones or powerful local transmitting stations nearby. Switch off mobile phones while troubleshooting noise problems.
- > If you are feeding the signal to recording equipment or a mixing console via the amp's *Line Out* and the XLR Ground (49) button is set to Pin 1 to Ground, the problem may be a ground loop that has been formed with the connected device's ground. Set the button to Ground Lifted.

The electronic power amp protection circuit has tripped:

- > The given power tube is defective and must be replaced if the electronic circuit breaker continues to trip after several attempts to reset the Tube Monitoring System by flipping the Standby switch off and back on again.
- > The amp has been overloaded, perhaps by excessive volume levels, mains over-voltage, or the wrong output impedance (the impedance setting does not match the connected speaker's impedance).

Important note concerning the cooling fans:

To protect your amp from damage due to overheating, please ensure the cooling fans remains in operation at all times, especially during lengthy gigs or other occasions when your amp's operating temperature is high. For recording in the studio or other applications that demand absolutely silent operation, you may disconnect the power supply to the fan pulling the central power supply plug (see tube map on page 30). Ensure the fan is not off for longer period of time; one to two hours, depending on the ambient temperature.

Technical Data

Output power:	approx. 100 watts; adjusted accordingly to 4, 8 and 16 ohms;
Input sensitivity levels	
Input:	from -20 dB, nominal, max. 0 dB
Effect Return:	from -20 dB nominal, max. 0 dB
Output levels	
SEND, level range:	from -20 dB to approx. 0 dB max.
Frequ.Comp. Line Out:	max. +12 dB (balanced), +6 dB (unbalanced);
Power consumption:	approx. 330 watts max.;
Fuses:	
at 230/240 mains voltage	external: 2 ATL, internal: 2,5 ATL (T: slo-blo);
at 100/115/120 mains voltage	external: 4 ATL, internal: 5 ATL (T: slo-blo);
Important:	Replace these with fuses of the same type and rating only!
Tubes:	
V1, V2, V3, V4:	6L6GC or 5881, matched sets;
V5:	ECC83 F.Q., input tube;
V6, V7:	ECC83 selected;
V8:	ECC83 standard;
Consult Tube Map to view tube array	Replace tubes with selected sets only!
Logic control system:	
Processor, software:	AT89C52 μ C with internal 8K Flash Memory for software source code; Upgradeable with external Programmer;
Memory:	EEPROM 93C66 for data retention;
System interfaces:	Asynchronous data protocol according to the MIDI standard;
MIDI:	MIDI program changes 0 - 127; MIDI channels 1 - 16 MIDI controller 7 (main volume), value 0-5 = Master Volume Mute, Mute, value > 5 = default Master Volume level;
Serial Amp Control:	Proprietary ENGL asynchronous data protocol.
Cooling:	two fans each 12 Volts DC - 1,2 watts;
Dimensions E365 - 112:	approx. 57,5 x 48 x 27 cm (l x h x d);
Weight E365 - 112:	approx. 29 kg
Dimensions E368 - 212:	approx. 70 x 48 x 27 cm (l x h x d);
	approx. 70 x 55 x 27 cm including castors;
Weight E365 - 212:	approx. 38 kg

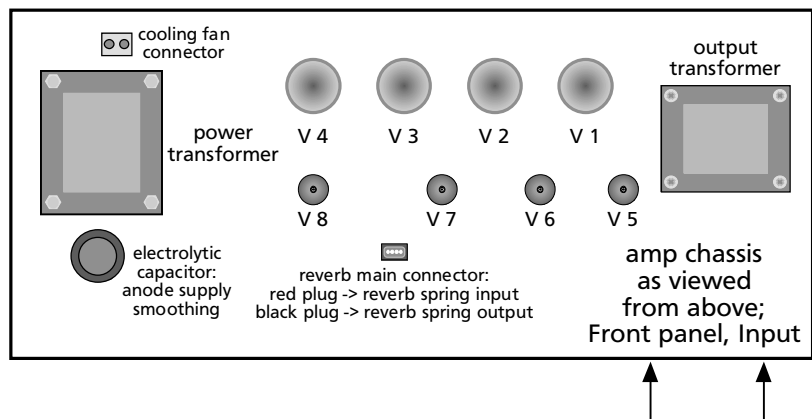
Tube Map:

the tubes and their function:

V 5 - ECC83 (12AX7): input stage, 2. stage; grade: FQ selected

V 6 - ECC83 (12AX7): Lead driver stage, 4. stage; grade: selected

V 7 - ECC83 (12AX7): FX buffer stage, poweramp driver stage; grade: selected

V 8 - ECC83(12AX7): phase splitter; grade: standard

V 1 - V 4: 6L6GC or 5881: power tubes, poweramp, matches sets

Tube replacement report:

1. Replaced on: _____ 20 ____ Replaced by: _____

Replaced tubes: _____

Reason: _____

2. Replaced on: _____ 20 ____ Replaced by: _____

Replaced tubes: _____

Reason: _____

3. Replaced on: _____ 20 ____ Replaced by: _____

Replaced tubes: _____

Reason: _____

Wiring of Principal Connectors

LINE OUT BALANCED (50), XLR male connector

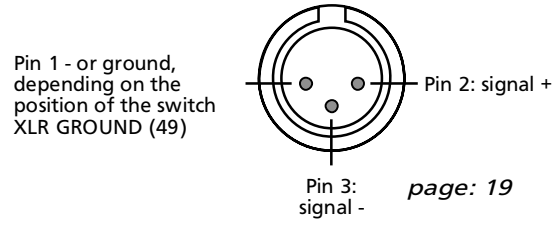

MIDI IN (33), DIN connector

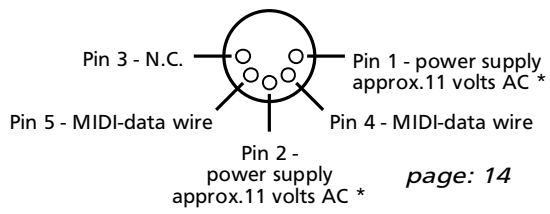

*: AC voltage is routed to pin 1 and 2 only when button 34 is set to ENGL MIDI Footcontroller.

Serial Amp Control Port (36)

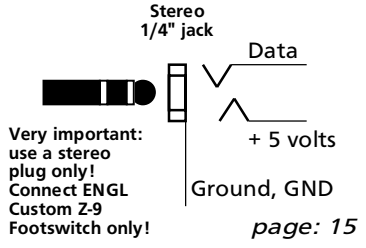

Dual Footswitch (37)

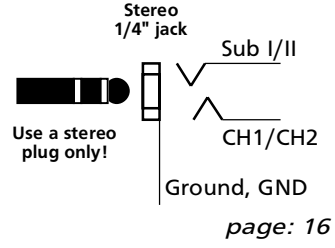

Options for controlling the ENGL Sovereign 100 amp remotely:

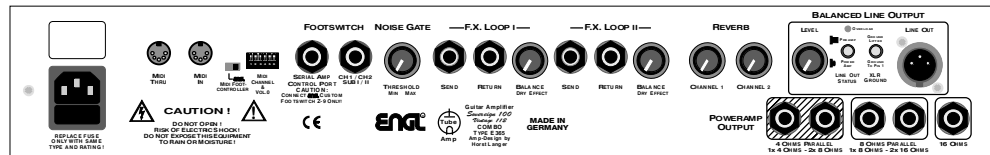

1./2. 2. 3.

1.

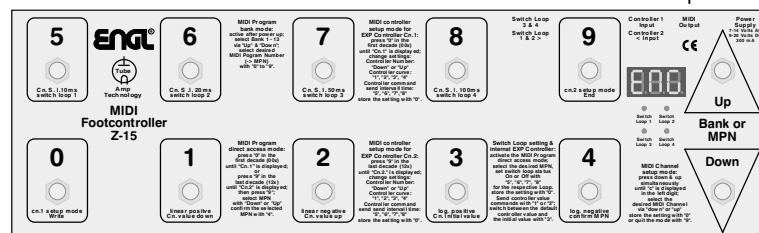

1. MIDI foot board (for example, the ENGL Z-12 or ENGL Z-15 pictured above): Connect the foot board to the amp using a standard 5-pin DIN cable. All 5 terminals of both connectors must be wired in a 1:1 configuration; MIDI data transmission requires two wires, and the ENGL MIDI foot board uses two more wires for purposes of power supply. This combination affords access to all of the amp's 128 MIDI presets. The Z-15 foot board also lets you control Master Volume Mute via MIDI controller.

1. 2.
↑ or ↑

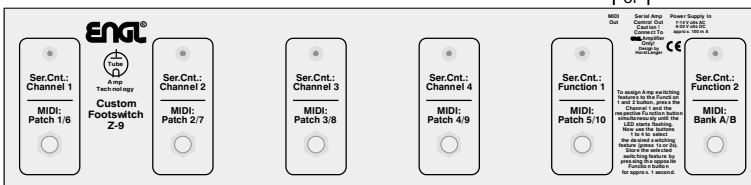

2. ENGL Custom Z-9 Footswitch: This special foot board connects to the amp via a 1/4" stereo cord plugged into the Serial Amp Port (36) or via a 5-pin DIN cord plugged into the MIDI IN port (33). The former option affords switching access to channels and two special functions (for example, *Hi Gain* or *Reverb*). In the latter setup, the Z-9 serves as a MIDI foot board that accesses the first 10 MIDI presets.

3. Two-way footswitch (e.g. ENGL Z-4): Connect two-way footswitches to the amp by plugging a stereo 1/4" cord into jack no. 37. Functions: Ch. 1/2 Ch. 1/2 (main channels) and sub channels Clean - Crunch and Lead I - Lead II. This means you can't activate sub channels directly, and must first switch to the other Main Channel. As an alternative to a two-way footswitch, you can connect a MIDI switcher (the ENGL Z-11 will do nicely) to this jack (37) to control the two switching functions.

3.

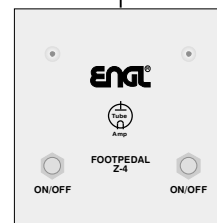

Noting Settings:

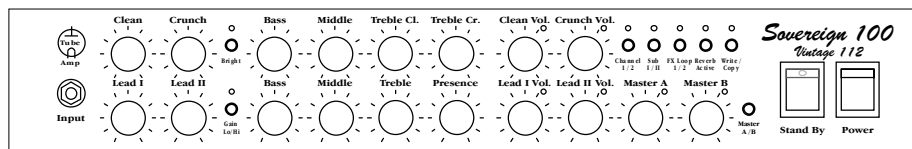

Sound title: -----

comment: -----

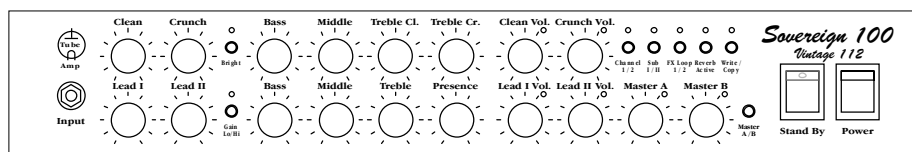

Sound title: -----

comment: -----

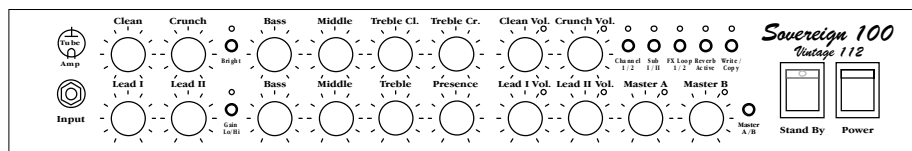

Sound title: -----

comment: -----

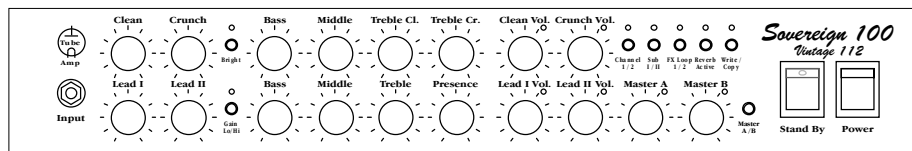

Sound title: -----

comment: -----

page: > 13 <

Saverign 100
Vintage 112

Stand By Power

The control panel features two rows of knobs and switches. The top row includes: Clean Vol., Crunch Vol., Treble Cr., Treble Cl., Middle, Bass, Bright, and Gain Lo/Hi. The bottom row includes: Lead I Vol., Lead II Vol., Presence, Master A, Master B, and Master A/B. Between the rows are three rotary switches: Channed 1/2, FX Loop Reverb Write / 1/2, and Sub 1/II. On the left side, there are two footswitches: 'Type Plate' and 'Type Plate'.

page: > 14 <

page: > 20 <

The rear panel includes: Type Plate, MIDI THRU, MIDI IN, a 5-pin MIDI controller, a Footswitch, a Serial Amp (CH1/CH2), a Footswitch (ON/OFF), a Noise Gate (THRESHOLD Min/Max), two F.X. Loop switches (I and II), Send and Return jacks for both loops, Balance and Direct switches for each loop, a Reverb control knob, two Channel 1 and Channel 2 reverb knobs, an I Balanced Line Output section with Level, Pa/Low, and Pa/High switches, and a Power Amp Output section with 4 Ohms Parallel, 8 Ohms Parallel, 16 Ohms, and 1x 4 Ohms - 2x 8 Ohms - 1x 8 Ohms - 2x 16 Ohms outputs. Safety warnings and CE and Tube Amp logos are also present.

page: > 20 <

Configuration table for assigning the Sovereign 100's sound-shaping and special functions to the Z-9 Custom Footswitch's *Functions 1* and *2* :

Button	Functions E365/E368	Setup	Indication	S.A.C.
<i>Function 1</i>	<i>Master A/B</i>	1: <i>Channel 1</i>	LED 1 lights	<i>F1-1</i>
<i>Function 1</i>	no	1: <i>Channel 2</i>	LED 2 lights	<i>F1-2</i>
<i>Function 1</i>	no	1: <i>Channel 3</i>	LED 3 lights	<i>F1-3</i>
<i>Function 1</i>	no	1: <i>Channel 4</i>	LED 4 lights	<i>F1-4</i>
<i>Function 1</i>	no	1: <i>Channel 1</i>	LED 1 flashes	<i>F1-5</i>
<i>Function 1</i>	<i>Gain Lo/Hi</i>	1: <i>Channel 2</i>	LED 2 flashes	<i>F1-6</i>
<i>Function 1</i>	<i>Bright</i>	1: <i>Channel 3</i>	LED 3 flashes	<i>F1-7</i>
<i>Function 1</i>	no	1: <i>Channel 4</i>	LED 4 flashes	<i>F1-8</i>
<i>Function 2</i>	no	2: <i>Channel 1</i>	LED 1 lights	<i>F2-1</i>
<i>Function 2</i>	no	2: <i>Channel 2</i>	LED 2 lights	<i>F2-2</i>
<i>Function 2</i>	no	2: <i>Channel 3</i>	LED 3 lights	<i>F2-3</i>
<i>Function 2</i>	<i>Reverb</i>	2: <i>Channel 4</i>	LED 4 lights	<i>F2-4</i>
<i>Function 2</i>	no	2: <i>Channel 1</i>	LED 1 flashes	<i>F2-5</i>
<i>Function 2</i>	no	2: <i>Channel 2</i>	LED 2 flashes	<i>F2-6</i>
<i>Function 2</i>	<i>FX Loop 1/2</i>	2: <i>Channel 3</i>	LED 3 flashes	<i>F2-7</i>
<i>Function 2</i>	no	2: <i>Channel 4</i>	LED 4 flashes	<i>F2-8</i>

Comments:

Column 1 lists the Function button on the Z-9. Column 2 lists the sound-shaping and special functions that can be assigned to it.

Column 2 lists sound-shaping and special functions on the ENGL Sovereign 100 Amp that can be controlled remotely via the Z-9 Custom Footswitch.

Column 3 lists the configuration or setting required to remote-control sound-shaping or special functions on the Sovereign 100.

The first digit indicates the *Function Setup* routine, that is, 1: for *Function 1 Setup* and 2: for *Function 2 Setup*.

Channel 1 to *Channel 4* denotes the button used to enter the setting.

Column 4 indicates the currently or newly selected configuration. For example, if LED 3 flashes when the Z-9's *Function 2 Setup* routine is activated, then the Sovereign's *FX Loop 1/2* switching feature is currently assigned to *Function 2*; the corresponding S.A.C. command is *F2-7*.

Column 5 lists the shorthand designations for specific configurations that appear throughout the Z-9 Operator's Manual. For detailed information, please refer to the Z-9 Custom Footswitch Operator's Manual.

Please note: The ENGL Z-9 Custom Footswitch is an optional accessory. The afore mentioned Function buttons, LEDs and setup routines pertain to the Z-9.



ENGL®

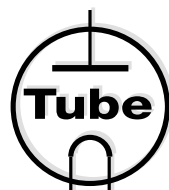

**Amp
Technology**

ENGL Gerätebau GmbH
Germany
Internet: <http://www.engl-amps.com>

Text, design, graphics, photography and layout by
Horst Langer, **ENGL** Amp Designer